







# ASSEMBLY INSTRUCTIONS

## MODEL 9006

- Provide a large working area to assemble the quilt rack.
- Check to see all listed parts on the drawing below are included in your box.

	A.	2" BARREL BOLT	* 8 PCS
	B.	BARREL NUT	* 8 PCS
	C.	WOOD BLOCK	* 8 PCS
	D.	FLAT WASHER	* 8 PCS
	E.	SPRING WASHER	* 8 PCS
	D.	HEX KEY	* 1PC

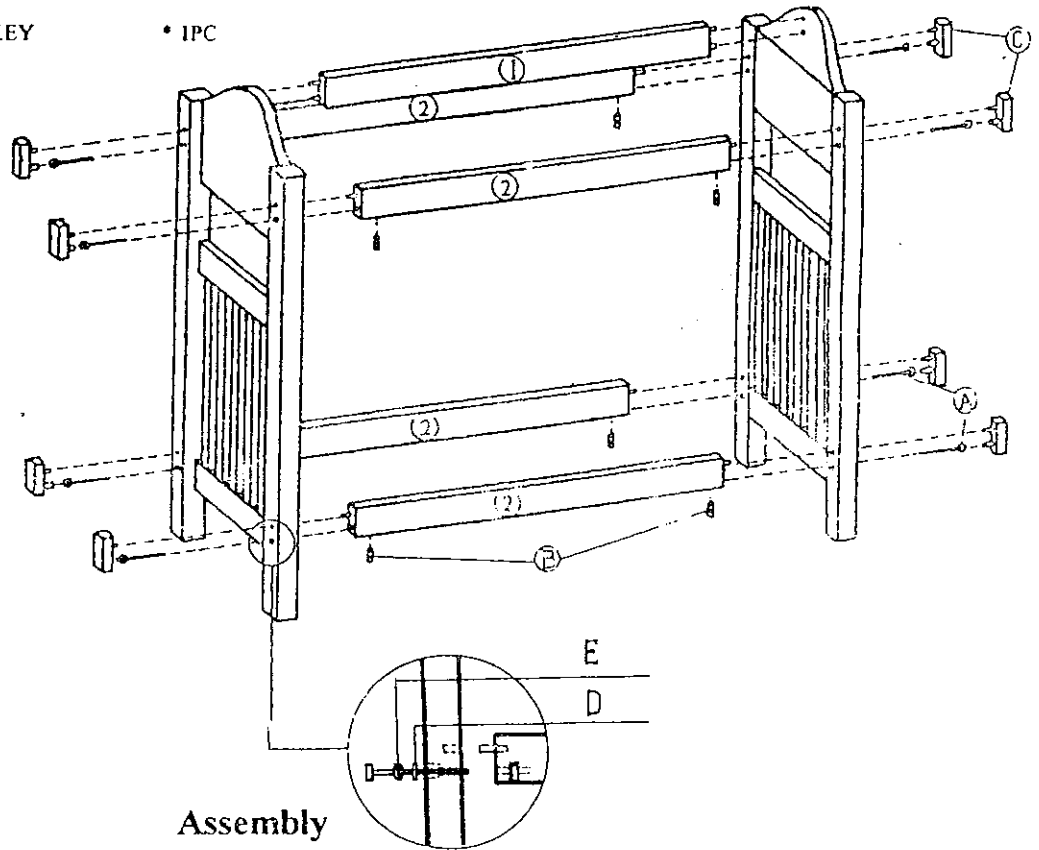

1. Attach stretcher ① to left side panel.
2. Attach stretchers ② to left side panel, and all the stretchers to right side panel.

3. Use parts marked (A), (B), (D) and (E) to tighten the stretchers ②.
4. Assemble the wood blocks (C) to cover bolt holes.

